

**yuwell**

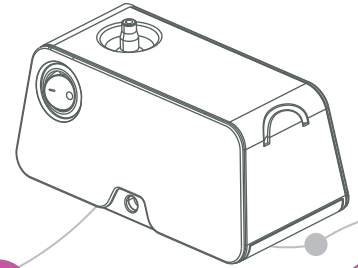

**405A/B**  
**Air-compressing Nebulizer**

**User's manual**

Please read the user's manual closely!

JIANGSU YUYUE MEDICAL EQUIPMENT & SUPPLY CO., LTD.  
Sales Center Address: Huanyuan East Road No.1, Xuzhuang Software  
Park, Nanjing, Jiangsu Province, P.R. China, 210000  
Manufacturing Address: YunYang Industrial Park, DanYang, Jiangsu  
Province, P.R. China, 212300  
<http://www.yuwell.com>

## Contents

<b>I. Features</b> -----	<b>01</b>
<b>II. Use and Maintenance</b> -----	<b>03</b>
<b>III. Sale and others</b> -----	<b>19</b>

## I. Features

### I. Summary

The 405A/B Compressor Nebulizer is intended to aerosolize medications for inhalation by the patient for respiratory disorders. It is a new generation of compressor nebulizer manufactured by the company based on innovation and improvement of similar products at home and abroad.

### II. Product performance and index

1. Power:  
Input: AC100-240V~ 350mA, 50/60Hz  
Output: DC12V, 1000mA
2. Maximum nebulization rate:  $\geq 0.2\text{mL/min}$
3. MMD:  $3.9\mu\text{m}$   
Percentage of nebulized particles with diameter less than  $5\mu\text{m}$   $> 65\%$  ※
4. Maximum pressure of compression pump:  $\geq 0.1\text{MPa}$
5. Free flow of compression pump:  $\geq 3.5\text{L/min}$
6. Noise:  $\leq 55\text{dB(A)}$
7. Net weight:  
405A about 260g (unit only)  
405B about 240g(unit only)
8. Size:  
405A Approx. 13cm (l)  $\times$  6.5cm (w)  $\times$  6.8cm (h)  
405B Approx. 14.5cm (l)  $\times$  8cm (w)  $\times$  5.6cm (h)
9. Taboo: None
10. Electrical safety requirements: Class II equipment, Type B applied part

11. Working system: intermittent operation – working for 20 minutes with an interval of 40 minutes

12. Normal working conditions:

Environmental temperature: 10℃ ~ 40℃ Relative humidity: 30% ~ 75%

Air pressure: 86KPa ~ 106KPa

13. Restrictions on transportation and storage:

Environmental temperature: -40℃ ~ +55℃

Relative humidity: 10% ~ 93%

Air pressure: 70KPa ~ 106KPa

※ Test conditions: The environmental temperature is 20℃ and the humidity is 53%. The test distance from the nebulizing aerosol nozzle is 10cm.

Test solution: 0.9% saline

(Change with test conditions and test solution)

#### Caution:

- ❗ If the storage temperature is below 5℃, apply the device only when the temperature meets normal operating conditions.
- ❗ Store this product in a well-ventilated room, and avoid violent vibration in transportation.

### III. Structural Features and Working Principles

1. The pressure source is DC compression pump.
2. Innovative designs, simple operation, compacted size, easy storage and portable.
3. Schematic diagram of working principles

The compressed air generated with the pump inside the main unit, when pumping out from the nozzle, can suck up the medication with the negative pressure between the nozzle and the air tube. The pumped-up medication when impacting on the

top of the septum can turn into very fine aerosol before ejecting to the outside.

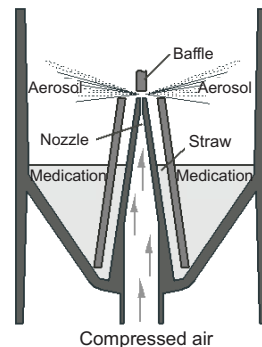

Figure 1

### IV. Electrical Schematic

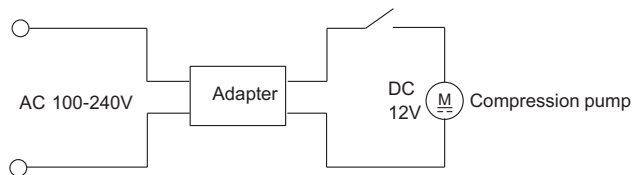

Figure 2: Electrical schematic

Electrical maintenance should be operated by professionals.

### II. Use and Maintenance

To ensure proper use of this product, please read this instruction manual carefully and operate strictly in accordance with the requirements of the manual. Please contact the supplier or manufacturer if there is any doubt.

## I. Open-package Checking

Users, before installing and commissioning, shall first check whether the appearance of the product is good, and whether the variety and number of attachments is in line with the list of accessories attached to the specifications. If there is any defect, please contact the supplier or manufacturer timely.

## II. Schematic of each components and names of the whole machine

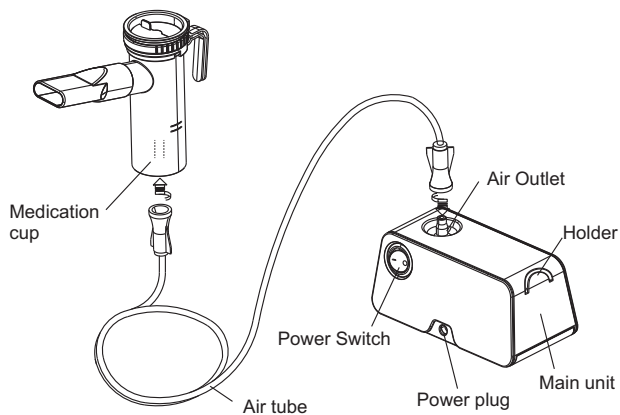

Figure 3: Schematic diagram of components (405A)

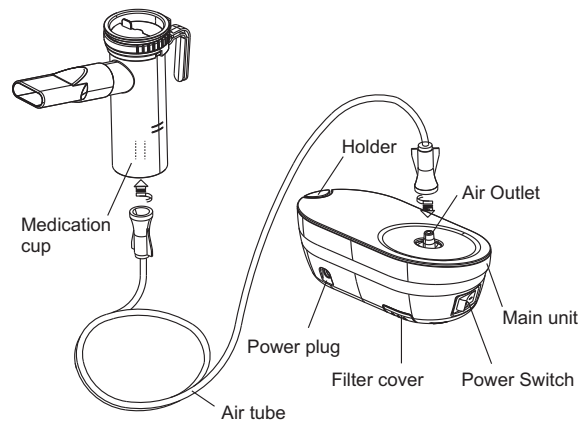

Figure 4: Schematic diagram of components (405B)

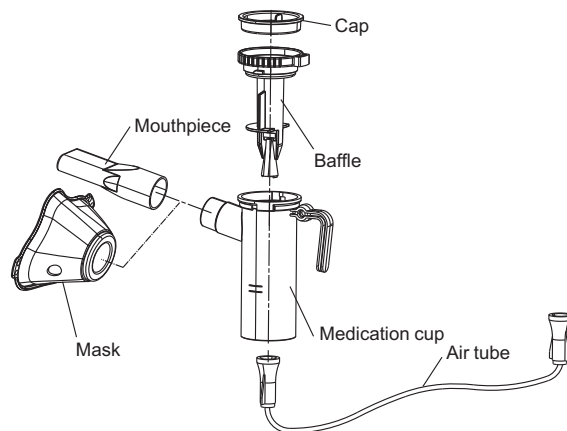

Figure 5: Schematic diagram of the nebulizer kit and accessories

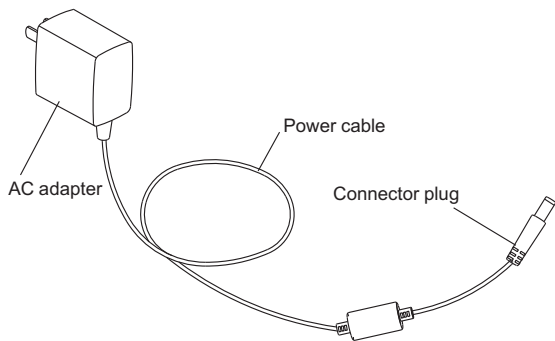
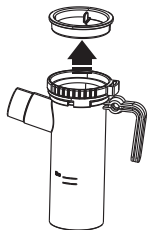

Figure 6: Schematic diagram of the AC adapter

### III. Preparing the Nebulizer for Use

1. Open the cap.



2. Add the correct amount of prescribed medication to the medication cup.

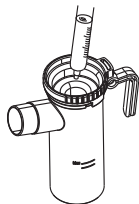

#### Caution:

- ⓘ Consult with physicians when nebulizing medication.
- ⓘ Pour the correct amount of medication into the medication cup and do not exceed the maximum mark.
- ⓘ The scale on the medication cup is a reference. Please use the scale on your syringe or vial for accurate measurement of

medication.

- ⓘ After the medication is added to the medication cup, please properly place the cup and avoid the dumping of the cup and the medication flowing outside.

3. Cover the cap and connect the mouthpiece or mask.

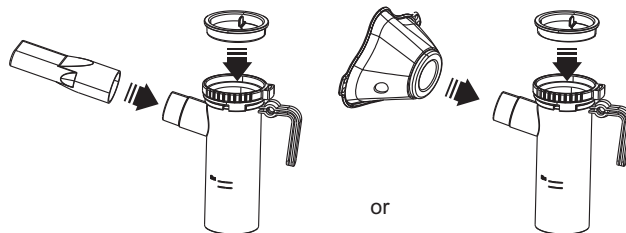

4. Turn the power switch to the off ("o") position.

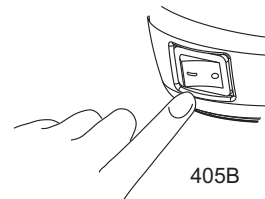
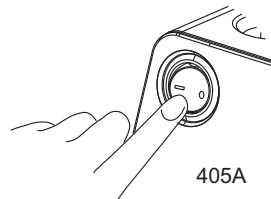

5. Plug the AC adapter with the main unit.

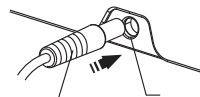

6. Plug the adapter into a power outlet.

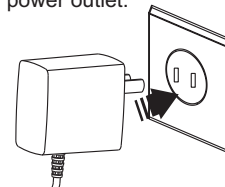

**Caution:**

- ① Make sure the AC adapter plug must be fully inserted into the power outlet when in use.
- ② Do not plug or unplug the AC adapter into the electrical outlet with wet hands.

※ **Use on holder**

Please use the holder when temporarily placing medication cup.

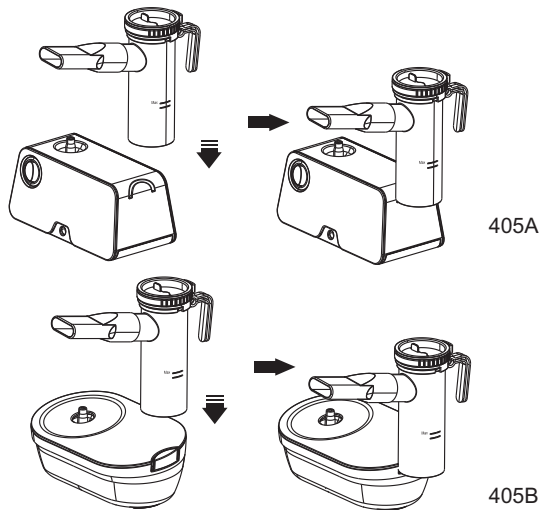

So far, preparation is ready

The included masks are premiums for the test machine. In official use, please purchase nebulization masks with medical registration certificate. The nebulizer kit are attachments. In addition to the accessories and other sold products, please do not use other components.

**IV. Steps**

1. Turn the power switch to the on ( \_ ) position

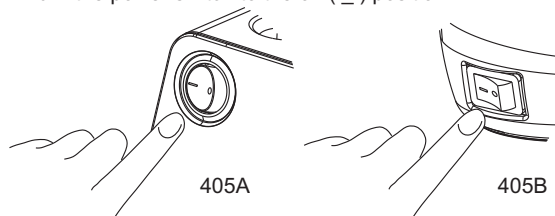

2. As the main unit starts, connect the air tube to the connector of the main unit and the medication cup respectively.

- 1) Connect one end to the main unit connector.
- 2) Connect the other end to the medication cup connector.

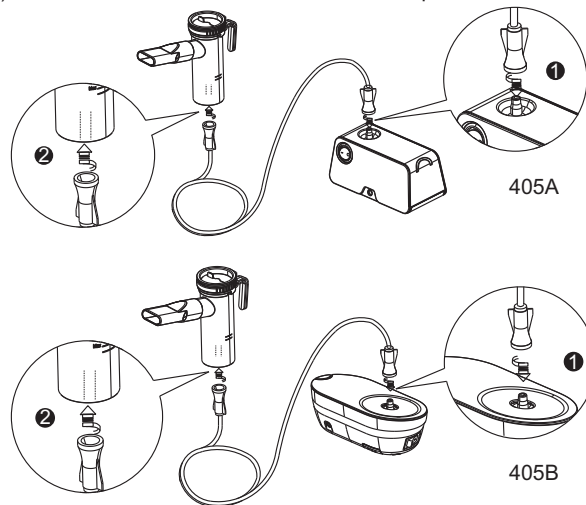

**Caution:**

- ① Make sure the air tube is firmly connected to the main unit and the medication cup.
- 3. Hold the nebulizer kit for treatment.

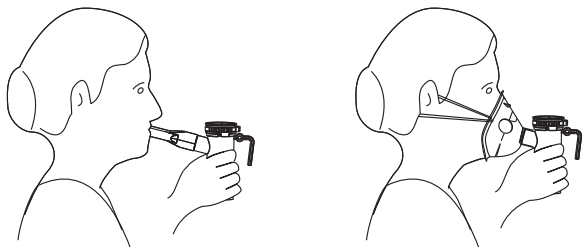

Inhaling with the mouthpiece or mask

**Caution:**

- ① In nebulization, keep the mouthpiece in mouth and close your mouth.
- ① Do not tilt the nebulizer kit so the angle of the kit is greater than 45 degrees. Medication may flow into the mouth and the spraying may be ineffective.
- ① If there is anything unusual in using, please stop using it immediately.
- ① In nebulization, check whether there is visible aerosol discharging from the medication cup. In the event of irregular spray, please immediately stop the treatment.
- ① Be sure to wipe the face after using nebulizer mask, and do not let the medication left in the face.
  - ※ Rotating the cap can properly adjust aerosol quantity.



- 4. After treatment, turn the power switch to the off (○) position.

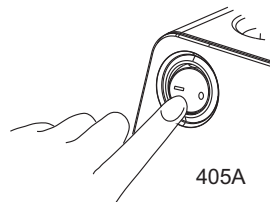

405A

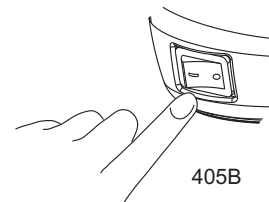

405B

- 5. Disconnect the nebulizer kit from the air tube.
- 6. Check the air tube. No condensation or moisture should remain in the air tube.
- 7. Disconnect the air tube.
- 8. Unplug the adapter from the power outlet.

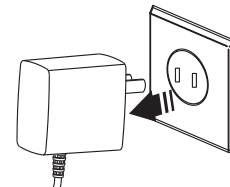

**Caution:**

- ① Do not pull the power cord strongly when unplugging it. Please hold the adapter and pull it out.

**V. Cleaning after Each Use**

**1. Cleaning**

Following cleaning instructions after each use will prevent any remaining medication in the bottle from drying resulting in the device nebulizing effectively and will help prevent infections. First, remove the baffle and accessories, discharge remaining medication in medication cup, and do related cleaning or disinfection.

**1) Baffle, mask and mouthpiece**

Rinse with clean water or immerse in warm water for 15 minutes

to ensure hygienic cleaning. Add appropriate amount of vinegar in the water, and then dry naturally in a clean place.

## 2) Main unit and air tube

Please wipe with moisturized cloth and then dry naturally.

### Methods for removing water inside the air tube:

- 1) Make sure the air tube is connected to the main unit.
- 2) Remove the air tube from the accessories of medication cup. After the main unit power is turned on, use fingers open and close the air tube ports repeatedly to exhaust water droplets.

### Caution:

- ⓘ Always dispose of any remaining medication in the medication cup after each use. Use fresh medication each time you use the device.
- ⓘ After cleaning, all attachments must be dried and then stored in a clean place.
- ⓧ Do not store the air tube when there is moisture or medication residue inside.

### Disinfection

Make sure the parts after each use are disinfected. If pollution is serious, please replace parts with new ones timely. There are two disinfection methods:

#### 1) Use a commercially available disinfectant. Please follow the instructions provided by the disinfectant manufacturer.

- a) Disinfectant soaking should be in accordance with the time required in the instruction manual of disinfectant. Rinse with clean warm water and allow to air dry in a clean environment.

### Caution:

- ⓘ After the nebulizer kit are removed from the disinfectant,

according to instructions on disinfectant, sufficiently wash the units with clean water, and take care to avoid residual disinfectant for disinfectant inhalation may cause worsening of symptoms.

- ⓘ If colored disinfectants (such as chlorhexidine) are used, after a long time using, there may be different color changes of units. This is not a problem on the physical properties. When color change is serious, please purchase separately sold items to replace.
- 2) Add enough water in the container, put parts that can be sterilized by boiling, heat up to boiling for 15 to 20 minutes. After boiling, carefully take out the units, shake off excess water and allow to dry in a clean environment.

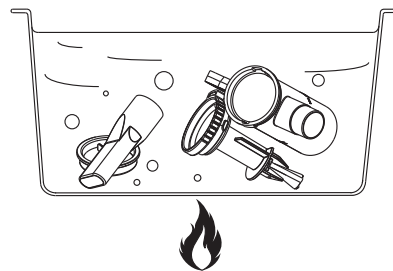





### Caution:

- ⓧ Do not cook the air tube, mask, filter, filter cover and accessories in boiling water or use boiling water to wash to prevent heat deformation.
- ⓧ In the disinfection process, please ensure the medication cup is empty.
- ⓘ When sterilized by boiling, be careful not to burn without water.



Please select the disinfection method listed in the following table:

Part name		Material	Sterilization by boiling	Ingredient: alcohol	
				Main disinfectant: disinfection with ethanol	
Mouthpiece		PP	○	○	
Mask		PVC	✗	○	
Nebulizer kit		PP	○	○	
Air tube		PVC	✗	✗	
Filter		PET	✗	✗	

## VI. Replacement of filter

Typically, a filter sheet shall be replaced every three months. If the air filter has changed color, replace it with a new one. If medication has spilled on the air filter, replace with a new air filter immediately.

1. Pull the air filter cover to remove from the back side of the compressor.

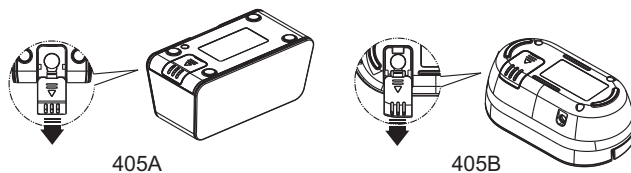

2. Replace the filter.

Remove the old filter sheet with a toothpick or other tools and then install a new one.

3. Install the cover of filter sheet.

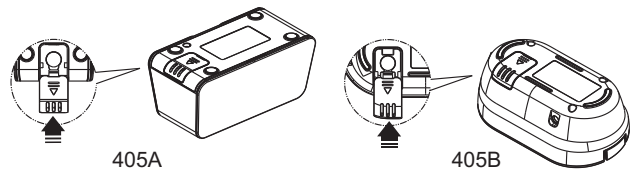

### Caution:









- ⚠ Before use, make sure the filter sheet is properly installed.
- ⚠ Please use the original filter sheet only and do not use the device if the filter sheet is not installed.
- ⚠ Do not attempt to wash or clean the filter sheet. Damp air filters may cause blockages. If water or medication has spilled on the filter, replace with a new air filter immediately.
- ⚠ Filter sheet has no positive or negative side.
- ⚠ Please confirm whether the filter sheet is clean and whether there is any stained dust before installing.
- ⚠ To prevent clogs, regularly clean the filter cover sheet with water (non-boiling) or other methods, dry naturally and install properly.

## VII. Maintenance

### Caution:

- ⓘ Do not use or store when the air tube is bending.
- ⓘ Do not let the main unit, nebulizer kit, AC adapter drop or subjected to strong shocks.
- ⓘ Do not apply force to the air tube and the nebulizer kit to deform.
- ⓘ Do not poke the nebulizer kit with needles or sharp objects.
- ⓘ Continuous use is prevented.
- ⓘ Do not disassemble the main unit or AC adapter or attempt to repair them.
- ⓘ Do not use or store in bathrooms and other damp places.
- ⓘ Do not put the main unit or other parts in extreme heat, cold or direct sunlight.
- ⓘ Do not use benzene, thinner, etc. to clean the air tube.
- ⓘ Please store product away from children, because for it contains small parts that may be swallowed.
- ⓘ Before maintenance, please unplug the AC adapter.

### VIII. Safety Symbols and Meanings in Operating the Device

Symbol	Meaning	Symbol	Meaning
	Type II device		Type B application
	OFF(power)		ON(power)
	Fragile items		Up
	Caution! Refer to attached files		Afraid of rain

### IX. Common Failure Analysis and Troubleshooting

No.	Symptom	Analysis	Solution
1	The device is abnormally loud.	The air filter cover is incorrectly attached	Attach the air filter cover correctly.
2	The main unit is not operating.	Power is not on.	Plug the adapter securely into an electrical outlet. Turn the device on.
3	No nebulization when the main unit is operating.	The nebulizer kit has been deformed in disinfection.	Replace the nebulizer kit or air tube.
		The nebulizer kit or air tube has been blocked or deformed.	
		Medication runs out.	Add the correct amount of prescribed medication to the medication cup.
4	There are water droplets in air tube.	The medication is excess or the air tube is not dried after cleaning.	After the air tube is connected to the main unit, repeatedly open and close the outlet of the air tube with a finger to get rid of water.
		In nebulization, there is condensation inside the air tube.	
If there are any other questions, please contact the supplier or manufacturer, or please turn to professionals for maintenance.			

## X. Notes

### 1. General Safety Precautions:

1) Check the main unit and accessories, confirm the existence of any problems and pay particular caution to the following:

- a) Outlet and the air tube are not damaged.
- b) Outlet and air tube are not blocked
- c) The main unit and nebulizer kit can work properly.

2) When using this device, there will be some noise and vibration caused by the pump in the compressor. There will also be some noise caused by emission of compressed air from the nebulizer kit. This is normal and does not indicate a malfunction. It will not affect the product life.

3) During the use, the main unit may heat up.

4) Operate the device only as intended. Do not use the device for any other purposes.

5) Do not operate the devices at temperatures greater than + 40 °C .

6) Limit use to 20 minutes at a time, and allow a 40 minutes interval before using the device again.

7) Please unplug the AC adapter from the power outlet after use for complete disconnection from the power supply.

8) Be careful not to let the power connection socket at the bottom of the main unit and the connection part of AC adapter stain with medication or dust, otherwise, wipe it off quickly with a gauze or cotton swab.

### 9) Term of safety use: 3 years (except for wearing consumable parts)

10) The Caution and warnings in this description are for proper and safe use of the product, and the prevention of harm to the

user or others or damages. Warnings and notes are in the following:

Legend	Content
Caution	It indicates that misuse may lead to personal injury or property damage.
ⓘ	The symbol ⓘ indicates mandatory (something that must be followed). Specific mandatory content is in ⓘ or is listed in nearby text or drawings. The left picture shows "general mandatory."
⊘	The symbol ⊘ indicates prohibition (something that must be followed). Specific prohibited content is in ⊘ or is listed in nearby text or drawings. The left picture shows "general prohibition."

- ⓘ For patients in coma or sputum patients, please follow the instructions of your physician or licensed healthcare practitioner about the type, dose and regime of medication.
- ⓘ Clean and disinfect the nebulizer kit, mask or mouthpiece before using them for the first time after purchase.
- ⓘ If the product has not been used for a long period of time, clean and disinfect the nebulizer kit, mask and mouthpiece before using them.
- ⓘ When people use the product, replace the supporting disposable nebulizers (be sure to replace the nebulizer kit and the mouthpiece or mask), or it may cause infection.
- ⓘ When drying the main unit or dried parts, do not use a microwave oven, cutlery dryer or hair dryer.
- ⓘ Do not put fingers or any other objects into the main unit.
- ⊘ Do not use water in the nebulizer for inhaling purposes.
- ⊘ Please use nebulizer kit, air tube and filters manufactured by

Yuwell.

- ⊗ Do not use damaged components, mouthpiece, mask and air tube.
- ⊗ Do not cover the main unit and AC adapter with a blanket or towel, or any other type of cover during use.
- ⊗ When the main unit is in normal operation, in addition to cutting off power supply and other necessary operations, do not touch the main unit and AC adapter.
- ⊗ This device is approved for human use only.
- ⊗ Do not use or store the product where the device may be exposed to toxic or volatile gases.
- ⊗ Do not use a mobile phone near the product.
- ⊗ Do not use the product when surrounded by flammable gas.
- ⊗ Provide close supervision when this device is used by children.

## **2. Notes on the power supply**

- ① Wipe off the dust on the AC adapter before use.
- ⊗ Do not use other non-certified AC adapters.
- ⊗ Do not operate the device with a damaged power cord or plug.
- ⊗ Do not wound the cord of AC adapter on the main unit or AC adapter.
- ⊗ When not in use for a long time, unplug the AC adapter.
- ⊗ Unplug the adapter from the main unit after use.
- ⊗ When a power outage occurs during use, turn off the power switch immediately and unplug the AC adapter.
- ⊗ After use and before cleaning, be sure to unplug the AC adapter.
- ⊗ Do not spill water or other liquids on the compressor and AC adapter. These parts are not waterproof. If liquid spills on these parts, immediately unplug the AC adapter and wipe off the liquid with gauze or other soft absorbent material.

## **III. Sale and others**

### **I. Sale**

1. If there is any quality problem caused by non-human factors within one week from the date of sale, the company is responsible for the refund, replacement and repair; under normal use and storage conditions, if there is any quality problem within one year dating from the date of the product shipping out of the factory, the company will provide free maintenance; if there is any quality problem after one year since the date of the product shipping out of the factory, the user can take invoice and warranty card to service department, office or dealer, and the company provides maintenance for parts with reasonable fees. If the user cannot provide invoices, identify according to the company letter or the date of manufacture with the extension of a month.

2. The following cases are not covered by the warranty: ① vulnerability consumables: filter sheet; ② failure caused by disassembling, repairing, or altering the product arbitrarily; ③ failure caused by accidental dropping in use or in the process of moving; ④ damage caused by improper use; ⑤ water, medicine and other liquid in the main unit caused by users; ⑥ failure caused by wrong operation not following the instructions; ⑦ damaged caused by unforeseen natural disasters (such as: floods, earthquakes, fires, etc.).

3. If necessary, please provide circuit diagrams and repair information. If there is any difficult problem in repairing the electrical circuit, please contact the manufacturer.

## II. List of accessories

Attachment	Quantity
Main unit	1
Nebulizr kit	1
Mouthpiece	1
Air tube	1
Mask (premiums for testing)	2 (One for adults and the other for children)
AC adapter	1
Filter	5
Instruction manual	1
Warranty (Certificate)	1

If there is any need for parts and accessories, please contact the supplier.

## III. Using an electromagnetic environment guide

1. This applies to the following situations, including hospitals, family and other architectures connecting with civil low voltage power supply network.

## IV. Processing of waste and residue

The processing of discarded main unit, accessories and other products should be in accordance with the provisions of the local government.

## Inform:

1. For machine damages and failures caused by improper use or not following the instructions, the company shares no responsibility.
2. When the conditions of temperature, voltage, and product characteristics are not in line with defined indicators, the main unit may not operate.
3. Product performance may vary depending on the characteristics of the medication (suspension or high viscosity).

The company reserves the rights to change the product technology and appearance. Please don't mind!